



MORE POWER : LESS NOISE



Congratulations, you have purchased the finest exhaust product for your touring motorcycle. This Vance & Hines exhaust product is JMCA approved for highway use in the Japan when installed on 2009-2011 Harley-Davidson Touring models equipped with the Twin Cam 96 engine. Please follow the installation instructions below and if you have any questions, please call our technical support line at (562) 926-5291, or e-mail us at TECH@VANCEANDHINES.COM Attention installer (if other than owner), please forward this instruction sheet to the owner of this product. These instructions contain valuable information to the end user.

**TOOLS
REQUIRED**



Slot Screwdriver



5/16 Nut Driver

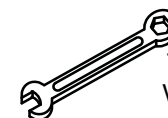

1/2" & 9/16"
Wrenches

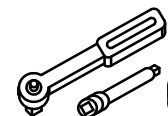

3/8" Drive
Ratchet w/
4" extension
1/2" & 9/16"
deep sockets

READ ALL INSTRUCTIONS BEFORE BEGINNING INSTALLATION

**STOCK EXHAUST
SYSTEM
REMOVAL**

1. Remove both saddlebags and set them aside.
2. Loosen the bolt from the pinch clamp on the front end of each muffler. NOTE: On the older model Dresser, spread the clamps just enough to remove them.
3. Working with one muffler at a time, support the muffler (assistance may be required) while removing the 5/16" bolts from the saddlebag support and slide muffler off of the head pipe.
4. Repeat the process for the opposite muffler. NOTE: It may be necessary to use a penetrating lubricant to loosen the muffler from the head pipe.
5. Leaving the grommets in place, remove the stock mounting brackets from the rubber grommets located on the saddlebag supports (Figure 1). NOTE: Inspect the grommets to verify that they are in good condition, if the grommets are damaged they will need to be replaced.

FIGURE 1

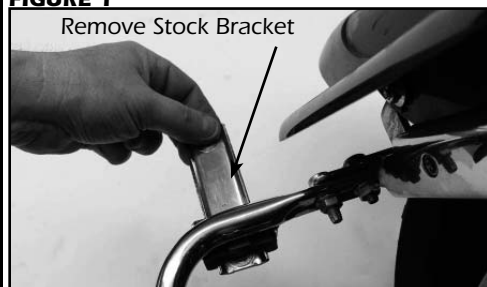

FIGURE 2



FIGURE 3



FIGURE 4

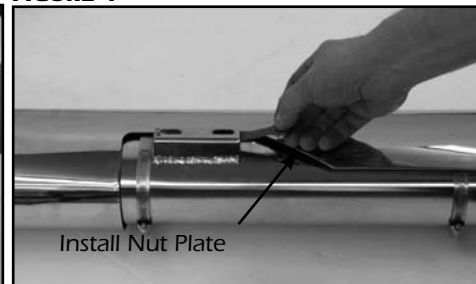
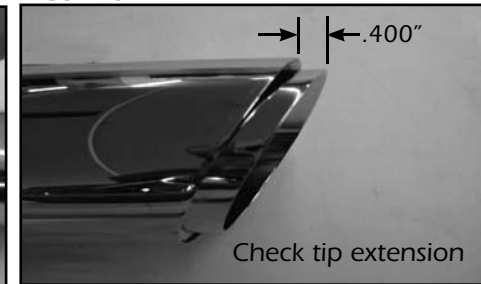

FIGURE 5



1. Install the #507-P muffler brackets (supplied) into the grommets on the saddlebag supports so that the tongue faces upwards (Figures 2). NOTE: Use of penetrating lubricant may help to slide the bracket into the grommet.
2. Install the Torca band clamps (supplied) over the front of each muffler so that the bolt is to the inside and the nut is facing down (Figure 3). NOTE: New Torca band clamps are supplied, do not use the old clamps.
3. Slide nut plates inside the brackets welded to backside of muffler bodies (Figure 4). While holding nut plates, slide muffler over stock exhaust head pipe and carefully attach muffler bodies to the mounting bracket using the supplied 5/16"-18 x 5/8" flange head bolts (leave them loose at this time) NOTE: Muffler heat shield is placed under head pipe heat shield (for both Stock and V&H Duals replacement heat shields).
4. Repeat installation procedure for opposite muffler.
5. Align mufflers and tighten hardware, beginning with the 5/16"-18 x 5/8" flange bolts on the mounting brackets.
6. Tighten the Torca Band Clamps. (45 Ft/Lbs Torque Spec) NOTE: You may want to use an assistant at this time to visually check alignment while you tighten the hardware. Pay special attention to making sure the muffler does not droop when viewed from the back of the motorcycle.
7. Check that the tip extends .400" past end of muffler heatshield (Figure 5). Adjust if necessary.
8. Tighten all heat shield clamps.
9. Replace the saddlebags.
10. After installation and before starting motorcycle, completely clean pipes and mufflers with cleaning solvent and a clean, soft cloth that will not leave a residue. NOTE: Any residue, oil, or fingerprints will stain the chrome when the metal heats up.
11. Be sure to tighten all hardware before starting your motorcycle.
12. IMPORTANT: AFTER TEST RIDE LET PIPES COOL DOWN AND RE-TORQUE TORCA MUFFLER BAND CLAMP.

EXHAUST CARE - HELPFUL HINTS TO AVOID DISCOLORATION OF EXHAUST SYSTEM

1. When installing a new set of chrome pipes, make sure your hands are clean and free of oil. After installation, thoroughly clean pipes with a soft cloth and cleaning solvent that will leave no residue (chrome wax / polish, glass cleaner, alcohol, ammonia, etc...) before starting the motorcycle.
2. Avoid long periods of idling as this can cause discoloration.
3. Intake leaks can cause the engine to run lean and overheat, this could lead to discoloration.
4. Make sure there are no exhaust leaks at the junction of the exhaust pipes and cylinder head. We recommend replacing gaskets if they are worn.

VANCE & HINES OPTIONAL ACCESSORIES

FUELPAK



FUEL MANAGEMENT:
Take the guess work out of fuel injection with Fuelpak Fuel Management. Contact your local dealer or call (562) 921-0071 to order. Visit fuelpakfi.com for more information. Fuelpak is intended for racing or off-highway use only, and is not legal for sale or use in California on pollution-controlled vehicles.



AIR FILTER KIT:
Our Air Filter Kit, like Fuelpak is made the Vance & Hines way; engineered and manufactured entirely in-house with an all aluminum venturi to shape the air for improved flow, a precision formed steel cover for a distinctive design that is a perfect match for any exhaust system. Includes a high-flow washable and reusable air filter.

PLEASE NOTE: Every effort is made for Vance & Hines Exhaust Systems to provide improved cornering clearance. However, due to design and space limitations on some motorcycle models, ground and cornering clearance may not be improved and in some cases may be reduced. Be sure to follow proper installation instructions.



PACKING LIST

MORE POWER : LESS NOISE

ALL PARTS SHOWN ARE ACTUAL SIZE

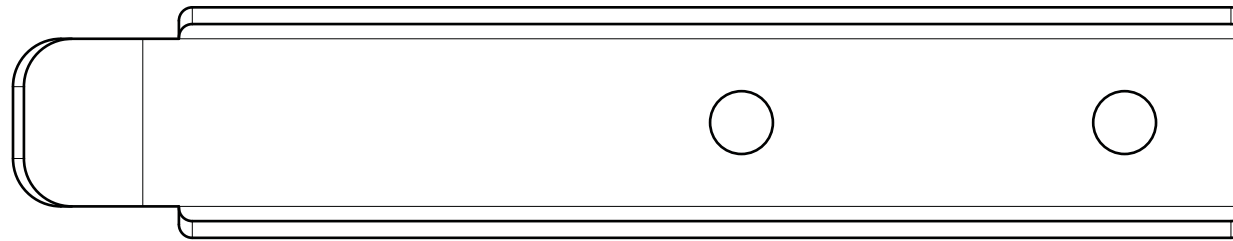

Mounting Bracket x 2

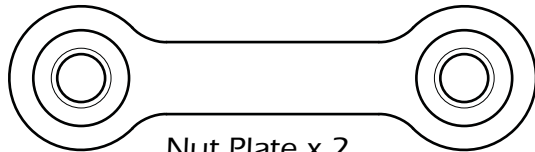

Nut Plate x 2

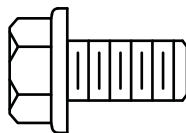

5/16-18 Flange Head Bolt x 4

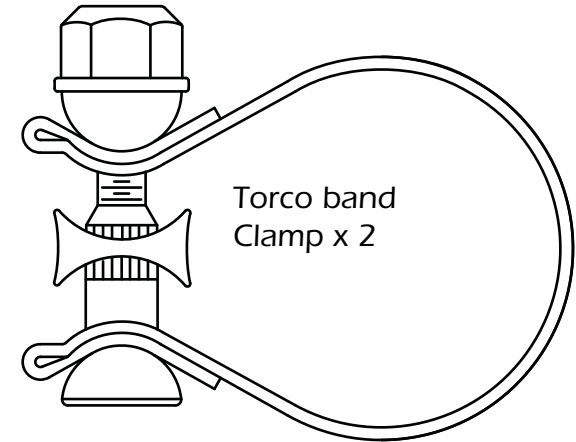

Torco band
Clamp x 2

PARTS NOT SHOWN:

- | | | |
|--------|-----------------------|----|
| D720RC | RH Muffler Casing | x1 |
| D721RC | LH Muffler Casing | x1 |
| D737HC | RH Muffler Heatshield | x1 |
| D738HC | LH Muffler Heatshield | x1 |
| D330EC | Slash Chrome End | x2 |

WARRANTY

Vance & Hines exhaust systems are warranted against defects in material and workmanship for a period of 90 days from the date of purchase from an authorized dealer. This warranty does not cover discoloration of chrome finishes. This warranty is limited to the repair or replacement of a product proven to be defective from normal use. Vance & Hines exhaust systems are designed to fit and operate on OEM motor and chassis. This warranty does not cover any product subject to abuse, misuse, improper installation or modification.

MORE POWER : LESS NOISE

このマフラーは平成11年、19年排出ガス規制に該当していますが、純正マフラー内の排出ガス発散防止装置(触媒)は取り外さず、触媒装置以降の交換となります。そのため、問題なく車検を受けることが出来ます。

車検時に触媒装置の有無について確認を受ける場合がありますので、受検の際は必ずこの確認書を持参してください。

自動車名・型式	ハーレーダビッドソン FLHX KB4 / FLTRX KH4
マフラーメーカー名	VANCE&HINES
マフラー名称	ツインスラッシュモンスタースリップオン
マフラーJMCA認定番号	JMCA2011109004

構成図

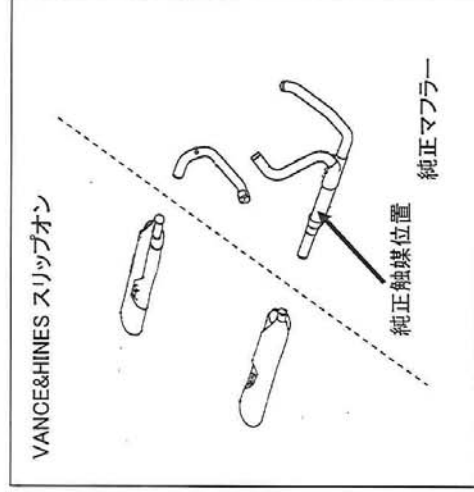

純正触媒の装着位置



純正触媒

製品と純正触媒の取付写真

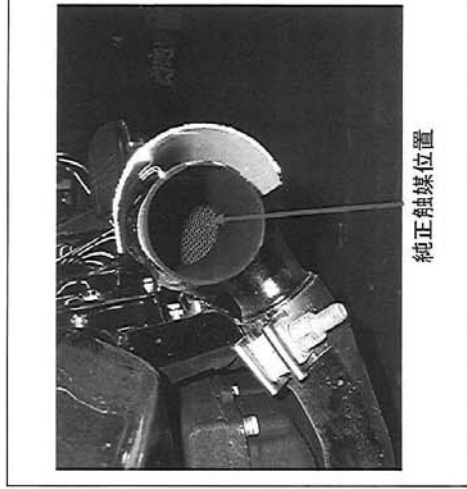

一般社団法人
全国二輪車用品連合会
東京都港区赤坂2-19-5-2F
TEL: 03-5545-7220
FAX: 03-5545-0038



MORE POWER : LESS NOISE

VANCE&HINES TWINSLASH MONSTER SLIP-ONS (品番: 16797) サイレンサーエンド部のボルトについて

株式会社プロト

サイレンサー後部にある4本のボルト(下記画像参照)は、エンドキャップを取付しているボルトであり、このボルトを取り外すことによるエンドバツフルやインナーサイレンサーの取り外しはできません。

■サイレンサー後部

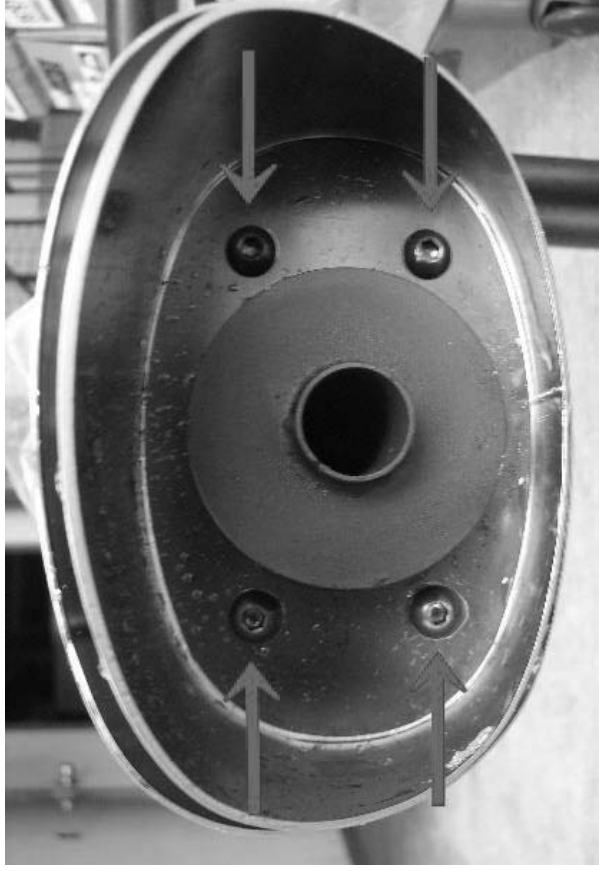

■構造図

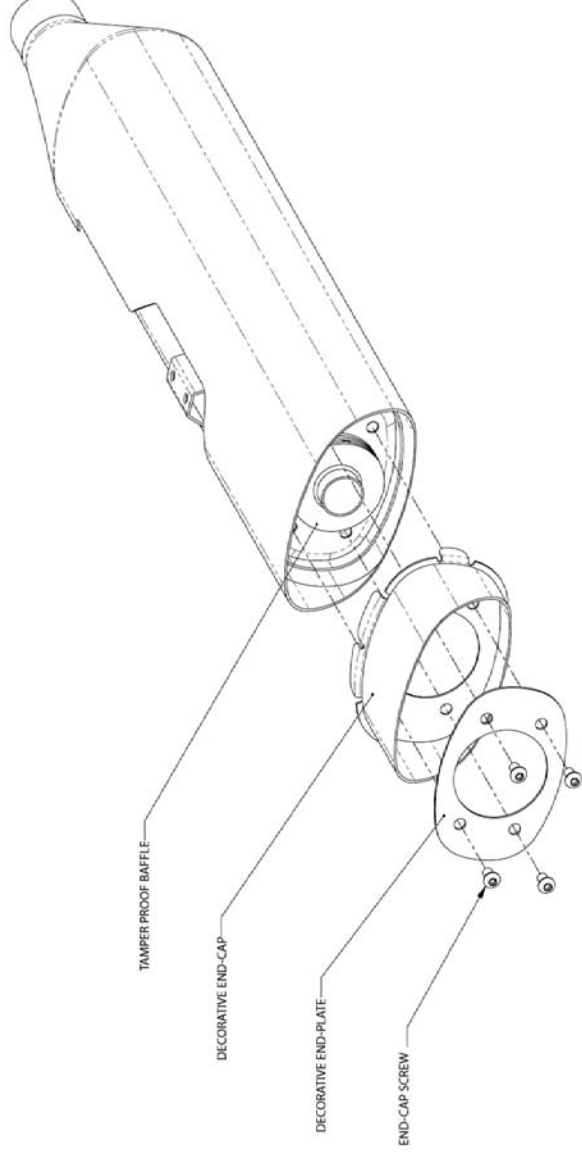

UNLESS OTHERWISE SPECIFIED:	NAME	DATE	SCALE: 1:4	WEIGHT:	SHEET 1 OF 1
UNLESS OTHERWISE SPECIFIED: DIMENSIONS ARE IN INCHES FRACTIONS ARE IN 16THS DECIMALS ARE IN 10THS HOLE DIMENSIONS ARE IN 16THS HOLE LOCATIONS ARE IN 16THS	DATE	16/05/11			
DESIGNED BY	CHK'D BY	ENG APPR	DATE		
DRAWN BY	CHK'D BY	ENG APPR	DATE		
REV	DWG. NO.	REV			
	A	TS MONSTER	NC		

TITLE: END CAP EXP VIEW